

ZANUSSI

**Instructions
for the use and care
of ZT 938
washing machine**

Contents

Installation

Unpacking	Page 3
Positioning & levelling	Page 3
Water connection	Page 4
Electrical connection	Page 6

Operation

Controls description	Page 7
Loading the clothes	Page 8
Filling with washing powder	Page 8
Use of additives	Page 8
Which powder?	Page 8
Selection of washing programme	Page 9
Starting	Page 9
Stopping	Page 9
Wash cycle	Page 10

Care and cleaning

Cleaning the machine	Page 12
Cleaning the drain collector	Page 12
Hints for care of washing powder dispenser	Page 13

Helpful tips for washing

Page 13

Servicing

Page 14

Technical data

Width

17,7 ins (450 mm)
Overall depth (excluding hose)
25,6 ins (650 mm)
Worktop height
25,6 ins (650 mm)

Dry clothes capacity
(excluding synthetic fabrics and wool)
10 lbs (4,5 kg)
Revolutions during spinning
400/800 r.p.m.
Total power absorbed
2700 W
Heater rating
2300 W

Motor rating during washing
400 W

Page 12	Motor rating during spinning
Page 12	500/600 W

Page 13	Water load: normal level
	3,2 gals (14,5 l)

Page 13	Water load: high level
	4,6 gals (21 l)

Page 14	Maximum water pressure
	110 p.s.i. - 759 kN/m ²

Minimum water pressure (cold)
7 p.s.i. - 48 kN/m²

Minimum water pressure (hot)
4 p.s.i. - 27 kN/m²

Supply voltage
220 ÷ 240 V

Supply frequency 50 Hz

Installation

Unpacking

After removing outer carton, reinforcing angles and polythene wrapping, proceed as follows:

1. tilt machine backwards, undo and remove the two screws located on the bottom of the appliance (Fig. 1); recover the relevant rubber washers and spacers;
2. remove the two cardboard strips (A - Fig. 1); undo and remove the two screws located on the back of the appliance (Fig. 2);
3. insert a screwdriver into the free holes left after removing the two screws, and tilt it as required to cause the two cardboard spacers to fall down.

Note:

It is advisable to keep all parts of the inner packings as these will have to be re-fitted in case the machine is to be transported again (e.g. when moving). Unpacking and levelling can easily be carried out with the aid of small wrench that comes with the machine (Fig 3).

Positioning & levelling

To allow easy movement, the machine is fitted with 2 fixed wheels located at the rear of the base plus a third small retractable wheel which can be dropped by turning the special lever (Fig. 4) to the left.

To steady the machine, return the lever back to its original position (Fig. 5). Then level the appliance very carefully by adjusting the levelling feet located at the front of the base and then tighten the lock nuts at the top of the feet (Fig. 6). It is recommended to perform this work very accurately to avoid any vibration, noise or shifting of the appliance during operation.

Also make sure that the washing machine does not touch walls, furniture, etc. while working.

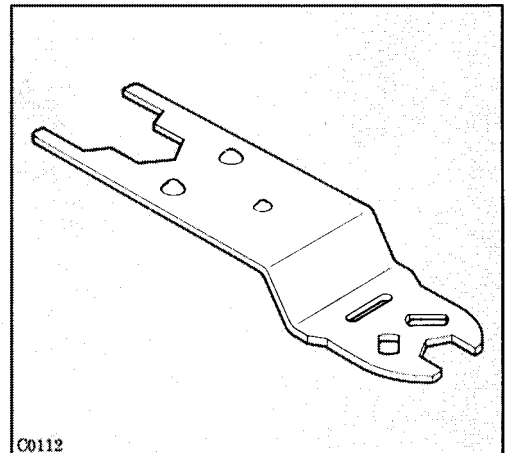
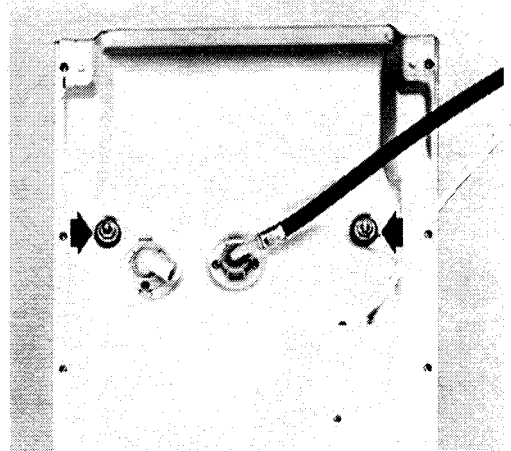
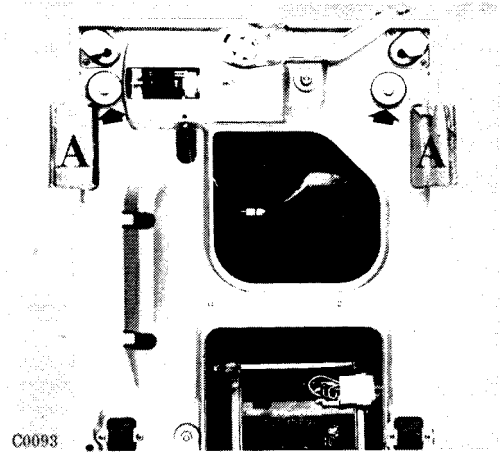

Water connection

The machine may either be plumbed in or connected to existing taps. Details are given below.

Water supply

Separate supplies of hot and cold water are necessary. Single outlet gas or electric heaters are not suitable. If only cold water supply is available, connect the two hoses to a cold water tap.

Note:The cold water fill hose and the drain hose are supplied separately, under the lid of the washer, and must be connected upon installation of the machine by going through a few simple steps. The drain hose should be fitted (with the straight end) over the special plastic connector to be found on the back of the washing machine, next to the hot water fill hose, and should then be fastened by means of the circlip hanging from the back of the machine. The cold water fill hose should be screwed, with the end shown in Fig. 9, onto the nipple to be found on the back of the machine, in the upper right part.

Water outlet connection

The adjustable drain pipe from this machine must connect into the main drain from the premises, but not into the rainwater drain. Information as to the type of drain servicing your premises can be obtained from a builder or the Local Authority.

The curved end of the outlet hose should be firmly hooked over the edge of a sink or connected to a suitable drain pipe in the wall or under the sink; however, such a drain pipe should have a built-in air break in order to avoid water syphoning from the machine during draining.

The top of the drain hose (curved end) should not be lower than 60 cms (23 ins) or higher than 90 cms (35 ins) from floor level (Fig. 7).

The water should be able to drain freely and the end of the outlet hose must not be under water.

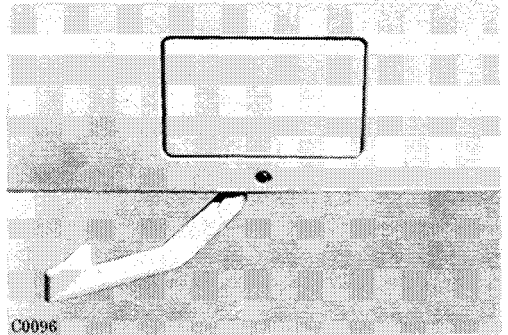

C0096
Fig. 4

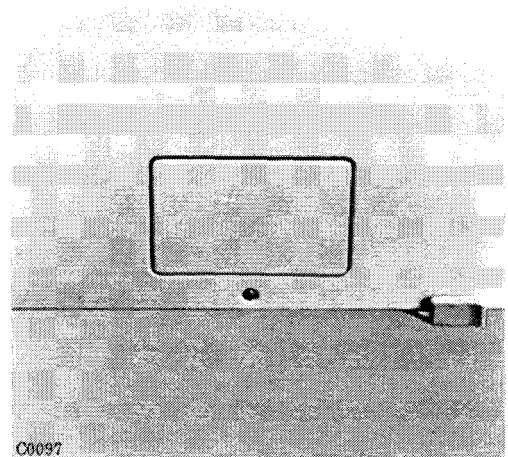

C0097
Fig. 5

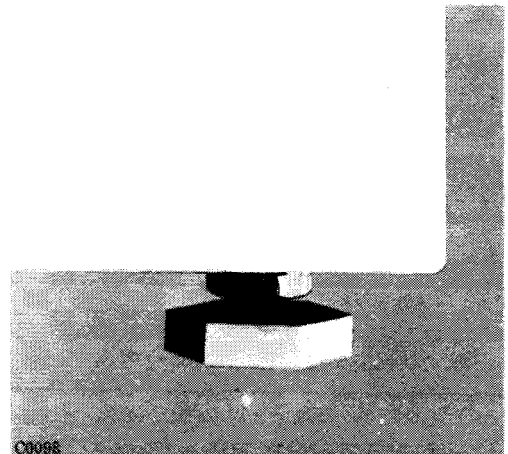

C0098
Fig. 6

It is therefore, advisable that the drain pipe, if used, has an internal diameter of at least 4 cms (1.5 ins).

Also, ensure that the drain hose is not chocked or placed in such a way as to obstruct the normal water flow. If the drain hose is to be hooked over the sink, ensure that the sink is empty and that the sink plug is not blocking the plug hole. If an extension is required, its inner diameter must be the same as that of the original hose of the washer and its length must not exceed 150 cms (5 ft).

Plumbed installation

It is important that work is carried out by a qualified plumber.

Use from existing taps

1. Mixer taps are unsuitable and must not be used.
2. Connect the red pipe connection to the hot tap and the other to the cold tap (see note below).

Important

If the rate of flow on the cold water valve is too slow, remove the flow control device of the valve. If the pressure on the hot tap exceeds approximately 10 lb. per square inch, it will be necessary to fit the flow control device, in the hot water valve.

Tap connections

For taps with a 3/4 inch gas thread, fit the washers to the inlet hoses and connect as shown (Fig. 8). The other end of the water inlet hoses, which are connected to the appliance, can be turned in any required direction by unloosening their ring nuts (Fig. 9).

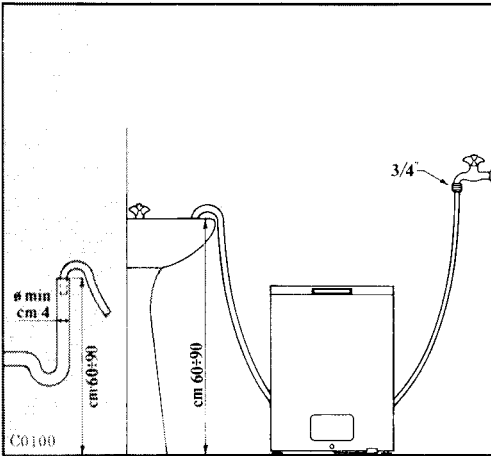

Fig. 7

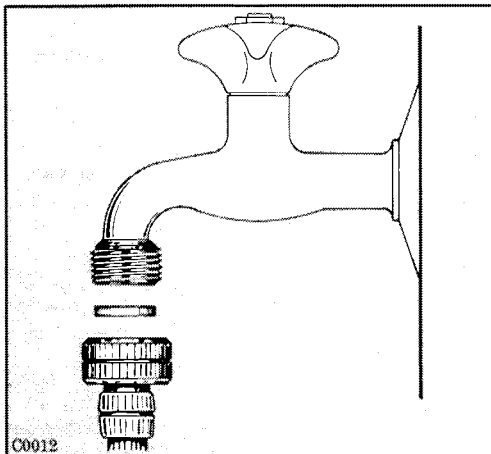

Fig. 8



C0099

Fig. 9

After setting the inlet hoses as desired, be sure to tighten their ring nuts again to prevent leakages.

If the water supply is from new pipes or from pipes which have not been used for a long time, it is advisable to run off a certain amount of water before connecting the machine. This will avoid foreign matter blocking the filters.

Additional hints for connection of water inlet hose

If the water supply in your area is hard it is possible that the filters situated in the fill valves can become blocked with sand or limestone deposits and in extreme cases this can cause a breakdown of the fill valves ie.; no water fill or continuous filling.

We would suggest that you install supplementary strainers which should be fitted on the fill hoses of your machine. For information about the availability of these supplementary strainers you should contact your local plumber.

Electrical connection

<p>WARNING THIS APPLIANCE MUST BE EARTHED</p>
--

The manufacturer declines any liability should this safety measure not be observed.

If the plug that is fitted to your appliance is not suitable for your socket outlet, it must be cut off and the appropriate plug fitted.

The cut off plug should be disposed of to prevent the hazard of electric shocks in case it should be plugged into a 13 Amp socket in another part of your home.

IMPORTANT

The wires in this mains lead are coloured in accordance with the following code:

**GREEN AND YELLOW - EARTH
BLUE - NEUTRAL
BROWN - LIVE**

If you fit your own plug, the colours of the wires in the mains lead of your appliance may not correspond with the markings identifying the terminals in your plug, this is what you have to do:

Connect the green and yellow (earth) wire to the terminal in the plug which is marked with the letter «E» or the earth symbol or coloured green, or green and yellow.

Connect the blue (neutral) wire to the terminal in the plug which is marked with the letter «N» or coloured black.

Connect the brown (live) wire to the terminal which is marked with the letter «L» or coloured red.

The plug moulded on to the cord incorporates a fuse. For replacement, use a 13 Amp BS 1362 fuse. Only ASTA approved fuses should be used.

The fuse cover/carrier must be replaced in the event of changing fuse. The right fuse cover/carrier colour is the one shown by the coloured insert at the base of the plug.

The plug must not be used if the fuse cover/carrier is lost. A replacement cover/carrier must be obtained from Zanussi Service Agents whose addresses are listed on the attached «Zanussi Service Agents Nationwide».

This appliance complies with E.E.C. directive no. 76/889 of 4.11.76 relative to radio interference suppression.

Operating instructions

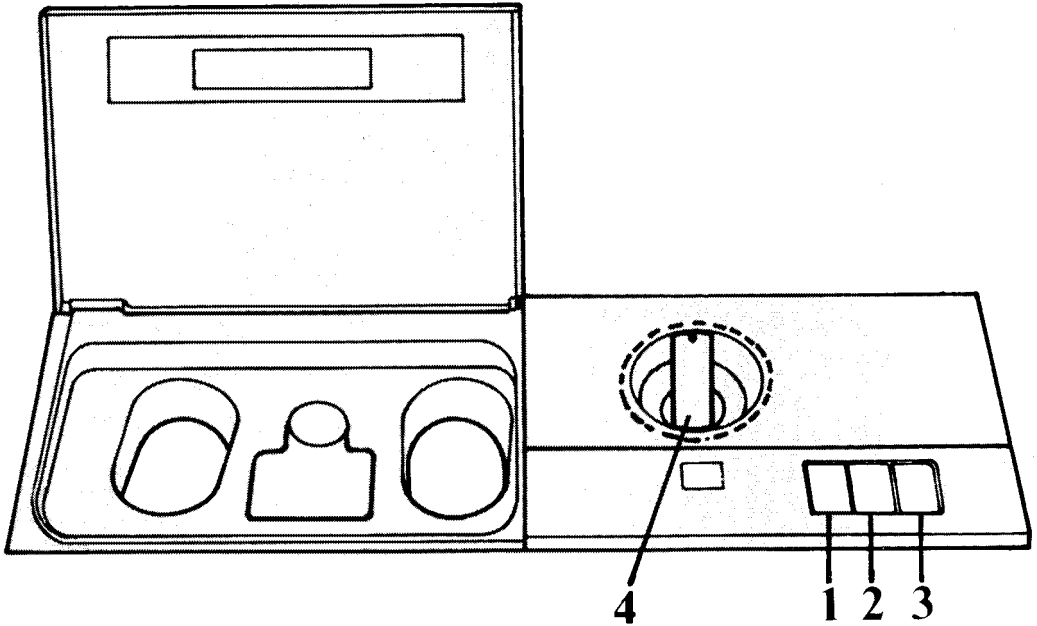

Controls description

1

Cold wash pushbutton : by pressing in this pushbutton prior to selecting a wash cycle, the programme will be carried out with cold water only.

A cold water programme is particularly suitable to wash very delicate synthetic fabrics, curtains, and drapes.

2

Spin pushbutton «800»: if pressed in at the beginning of an **energetic** wash cycle, this pushbutton provides the final spin at 800 r.p.m. instead of 400 r.p.m.

3

Half-load pushbutton : when pressed in, this pushbutton will provide a reduced load of water in the tub. This makes it possible, when washing only a reduced load (not more than half of the normal dry load), to obtain a reduced water consumption and a considerable saving in electric power consumption. This pushbutton should not be pressed in when washing synthetics or woollens.

2

Program selector: this permits selection of the required wash cycle by turning the knob clockwise until the letter corresponding to the desired programme coincides exactly with the pointer.
Furthermore, by pulling it or pushing it, it lets you start or stop the machine.

Loading the clothes

Lift the lid on the machine and turn the drum by hand until the loading door appears (Fig. 10).

Push safety lever A (Fig. 10) to the right and press it down until flap door C (Fig. 10) disengages. Fasten drum flap door B into the special slits F provided for the purpose, and then place the clothes in the drum taking care to spread them out evenly.

Close the loading door by overlapping flap C on flap B, making sure that safety lever A returns to its original position.

Filling with washing powder

The washing powder dispenser is located under the lid of the control panel. It is very important to use a low sudsing powder (see paragraph «Which powder») such as Persil Automatic, or Ariel Automatic.

Pull out the dispenser and add washing powder. The amount of washing powder for the prewash should be put into section «a» (Fig. 11) of the dispenser and the powder for the main wash should be put into section «b».

Use of additives

The washing machine is designed to carry out special treatments such as the addition of fabric conditioners automatically at the end of some washing programmes. The liquids to be used should be put into compartment «d» (Fig. 11) of the dispenser, after removing its small lid, at the beginning of the programme. These additives will be automatically used by the machine at the appropriate time.

Follow manufacturer's instructions for recommended quantities of these fabric conditioners; at any rate, the liquid should never exceed the overflow reference mark (MAX) in compartment «d».

Which powder?

Do not use ordinary powders like Radiant, Daz etc. in your new washing machine. The reason for this is very simple, these powders produce so much lather that clothes are prevented from tumbling freely and cannot get properly clean.

Do use the right powder. To get the best results, we recommend **Persil Automatic** or **Ariel Automatic**.

Like all modern automatic machines the ZT 938 works at peak efficiency with a low lather product.

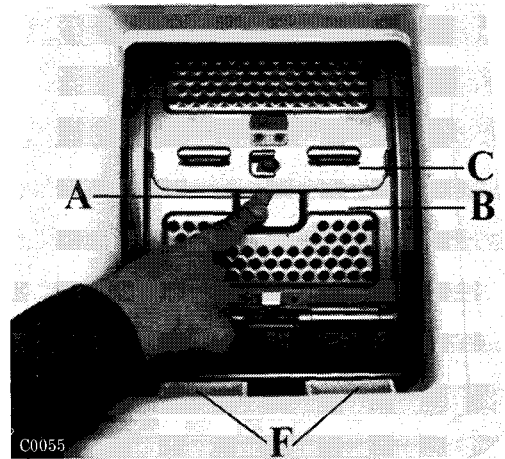

Fig. 10

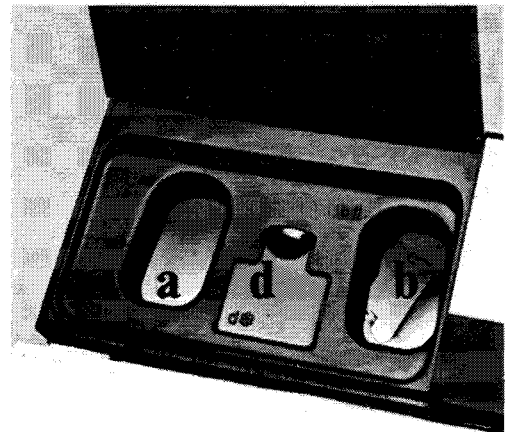

Fig. 11

These products' balanced lather are specially designed to complement the cleaning action of these machines. So use it regularly for trouble free washing and superb results.

The amount of powder in grams at full load			
Hardness of water in degrees French (°F)	Prewash	Wash when preceded by prewash	Main wash
Soft: up to 12	20	95	100
Average: 12 ÷ 25	60	145	170
Hard: 25 ÷ 37	95	200	235
Very hard: over 37	135	220	240

For hardness in p.p.m multiply indicated hardness value by 10.

For information regarding the degree of hardness in your area, enquire at your local water authority.

For reduced load or light soiling, reduce the quantities accordingly.

Do use enough powder. To get your clothes really clean it is essential that enough powder is used in the machine. The correct amount will depend on a number of things: the hardness of water, the size of the load, and the amount of soiling present.

As a guide we suggest you follow the table above and adjust the amounts in light of your personal experience.

You may find it helps to use a measuring cup at first.

Selection of washing programme

The washing machine carries out 10 washing programmes and 7 additional programmes. Each programme has been specially designed for a specific type of fabric (e.g. cotton, synthetic fibres, wool etc.) and incorporates the H.L.C.C. care labelling scheme.

The appropriate programme must therefore be chosen according to the type of fabric to be washed.

Starting

After loading the clothes, the washing powder and the fabric conditioners into the respective compartments, make sure — before you start the machine — that:

the plug is in the wall socket

the water tap is turned on (fully open)

the drain hose is correctly placed

the lid is correctly closed.

You may now select the required wash cycle by turning the programme control knob clockwise after making sure that it is pressed in.

To enable the spin only cycle to operate correctly it is essential that care is taken to ensure correct indexing. Failure to do this could result in damage to the appliance. Having selected programme J or U, ensure that the reference points on the timer knob are exactly in line with the reference points on the fascia panel.

Press in the required pushbutton, if any.

At this point, to start the washing machine simply pull the programme control knob (and the pilot lamp lights up). Once it is started, the machine will automatically carry out all phases of the selected programme.

Stopping





When the programme is completed the machine stops automatically.

You should now press in the programme control knob (pilot lamp goes out), and wait for about 1-2 minutes after the wash cycle is completed before you open the lid, so as to allow the door safety device (interlock) to release it. If need be, you may stop the machine at any given moment during the cycle by pushing in the programme control knob. If the machine stops during a spinning phase, it is absolutely necessary — to restart it — that you reset the machine on the programme immediately preceding the stopping point. When the wash cycle is completed, it is advisable to unplug the machine from the wall socket and to turn off the water tap.

Energetic wash cycle

For Cotton, Linen and Hemp Fabrics

Recommended wash load: 10 lbs (4,5 Kgs) max.







Wash cycle	Position of programme selector	Dispenser compartments to be used for		Wash cycle description
		washing powder	fabric conditioner, if any	
Universal wash	A	a		Prewash in water at 40°C (normal level) followed by a soaking phase (the laundry is left soaking in water). To drain the water, turn the programme knob to cycle «U» (drain with a gentle spin) or «V» (drain).
Whites-heavy soil 	B	a-b	d	Prewash in water at 40°C (normal level). Main wash in water at 95°C (normal level). 4 cold water rinses (high level). Spinning.
Whites 	C	b	d	Main wash in water at 95°C (normal level). 4 cold water rinses (high level). Spinning.
Fast coloureds 	D	b	d	Main wash in water at 60°C (normal level). 4 cold water rinses (high level). Spinning.
Non-fast coloureds 	F	b	d	Main wash in water at 40°C (normal level). 4 cold water rinses (high level). Spinning.
Rinses	G		d	4 cold water rinses (high level). Spinning.
Special treatments	H		d	Intake of water mixed with liquid additive (high level). Special treatments. Spinning.
Spin only	J			Spinning for about 6 minutes with simultaneous water draining. This is preceded by slow rotations of the drum.

Gentle wash cycles

For Delicates, Synthetics, Mixed Fabrics and Woollens

Recommended wash load: max. 3-5 lbs (1,5-2 Kgs); wool max. 2 lbs (1 Kg).

Important: There is no water draining in the last rinse of the gentle wash cycles, to prevent the clothes from creasing if they are left in the machine at the end of the wash cycle. To drain the water, turn the programme selector knob to cycle «U» (draining & gentle spinning) or cycle «V» (draining without spinning).

Wash cycle	Position of Wash cycle selector	Dispenser compartments to be used for		Wash cycle description
		washing powder	fabric conditioner, if any	
Special white cottons 	L	b	d	Main wash in water at 95°C (high level). 3 cold water rinses (high level).
White 	M	b	d	Main wash in water at 60°C (high level). 3 cold water rinses (high level).
Minimum iron 	N	b	d	Main wash in water at 50°C (high level). 3 cold water rinses (high level).
Delicates 	P	b	d	Main wash in water at 40°C (high level) with a steady drum. 3 cold water rinses (high level).
* Woollens  	Q	b	d	Main wash in water at 40°C (high level) with a steady drum. 3 cold water rinses (high level).
Silks 	R	b	d	Main wash in water at 30°C (high level). 3 cold water rinses (high level).
Rinses	S		d	3 cold water rinses (high level).
Special treatments	T		d	Intake of water mixed with liquid additive (high level). Special treatments.
Short spin only	U			Water draining followed by a short spin.
Drain	V			Water draining with a steady drum.

* This is a special cycle for washing wool garments bearing the woolmark label «Pure New Wool washing shrink resistant».

Care and cleaning

Cleaning the machine

Important: Make sure that the plug has been removed from the socket prior to undertaking any kind of maintenance. From time to time, carry out a complete cycle without a washing load, adding 1 oz of «Calgon». This should also be done when the washer has been out of use for a long time.

Leave the lid open for about 2 hours after the wash to allow air to circulate freely inside the machine.

Plated, polished and plastic parts and the glass door should be cleaned with a soft damp cloth, never with an abrasive cleaning powder.

For the cabinet exterior use a lukewarm solution of mild soap, then rinse and dry carefully. It is also advisable to clean the cabinet, from time to time, with a wax polish applied with a soft cloth.

Cleaning the drain filter

The machine incorporates a mechanical filter, located at the front bottom behind a small flap door, the purpose of which is to collect lint and any small object inadvertently left in the articles to be washed. If this filter is allowed to become clogged, it could make water draining difficult which would in turn result in poor rinses. This filter should therefore be cleaned regularly as follows:

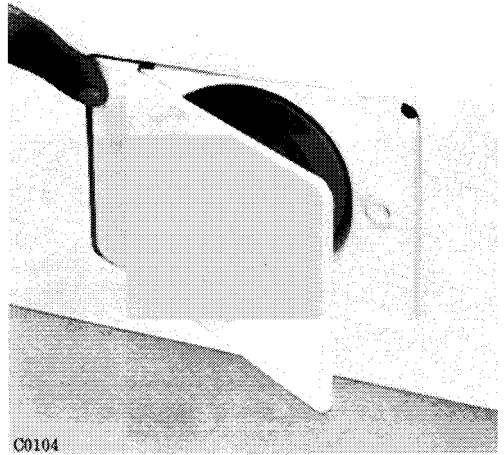

C0104
Fig. 12

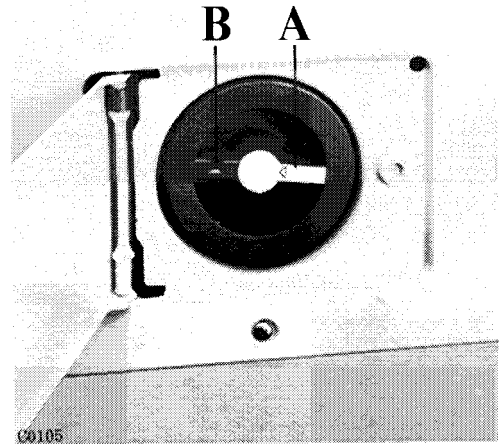

C0105
Fig. 13

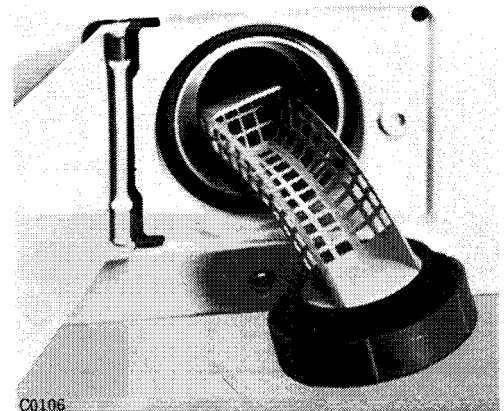

C0106
Fig. 14

Helpful tips for washing

Here are some practical hints to enable you to obtain the best washing results:

Use a low suds washing powder specially made for washing machines.

An excessive formation of suds will cause unsatisfactory operation.

The quantity of washing powder required depends on the amount of laundry and on how soiled it is. It may therefore be necessary to vary the quantities suggested in this book according to experience.

To obtain the best results when washing wool do not wash more than 2 lbs at a time.

In order to get good results when washing synthetic material use a maximum washing load of 4 to 5 lbs.

If your water is hard it can be softened by adding special products such as «Calgon» to the washing powder in compartment «b» (Fig. 11). These products facilitate the action of the washing powder and help to give better results.

Clothes should be sorted according to fabric type, degree of soil and colour fastness.

Tears and open seams should be mended, loose buttons secured, zippers closed and laces or belts collected in a cotton bag. Articles without a hem should not be washed. Ensure packets are emptied and spots of rust, paint, ink etc., removed before washing.

Always turn off water taps fully when the machine is not in use, even if it is plumbed in.

If, after commencing a wash, you find that the wrong programme has been selected, push the control knob fully in turning the indicator knob clockwise to the correct programme. Then pull control knob fully out again.

Open the flap door of the filter compartment by pressing it inwards with your finger at the hinged side (as shown in Fig. 12).

Shift safety slider A (Fig. 13) until the red notch B (Fig. 13) disappears.

Turn the filter knob counterclockwise and pull the filter out (Fig. 14).

Clean filter thoroughly.

Refit the filter and turn the knob clockwise until the red notch reappears.

Hints for care of washing powder dispenser

We recommend that the washing powder dispenser is checked regularly to ensure that it is clean and dry. Do wipe dispenser after each wash.

Washing powder should only be placed in the dispenser immediately prior to the start of a programme.

Do not leave washing powder in the dispenser for any length of time as it may form lumps which can be difficult to dissolve.

It is advisable to inspect the filters in the water inlet hoses periodically and clean if necessary.

Servicing

Should servicing be required for this appliance contact your local Service Agent but before requesting service the following simple checks may save you inconvenience and expenses:

- **The machine won't start**

Check that the plug is firmly in the wall socket and that there is an electricity supply by plugging in another appliance. Check that the lid of the machine is firmly closed.

Check that the required programme is correctly selected.

Check that the programme selector knob is actually pulled out;

Make sure the fuses of your electrical installation have not blown.

- **The machine won't fill**

Check that:

the water tap is actually turned on and that there is sufficient pressure.

The lid is firmly closed.

- **The machine fills, but the water empties from the drain hose**

Check that:

the end of the drain hose is not placed too low from floor level.

- **The machine won't drain or spin**

Check that:

the drain hose is not sharply bent (kinked) or placed in such a way as to obstruct a normal water flow.

The drain pump filter is not clogged.

- **The machine vibrates or is too noisy**

Check that:

the inner packing (transit security) was correctly removed, as described in paragraph «Unpacking».

The machine is correctly levelled and steadied as described in the relevant paragraph.

The washer is not too close to a wall or to the furniture.



ZANUSSI STANDARD GUARANTEE CONDITIONS

This guarantee is in addition to your statutory and other legal rights which will not be excluded or in any way diminished by the return of the guarantee card.

We, IAZ International (UK) Ltd, undertake that if, within twelve months (24 months for TV sets) of the date of the purchase, this ZANUSSI appliance or any part thereof is proved to be defective by reason only of faulty workmanship or materials, we will, at our option, repair or replace the same FREE OF ANY CHARGE for labour, materials or carriage on condition that:

—The appliance has been correctly installed and used only on the electricity supply stated on the rating plate.

—The appliance has been used for normal domestic purposes only, and in accordance with the manufacturer's operating and maintenance instructions.

—The appliance has not been serviced, maintained, repaired, taken apart or tampered with by any person not authorised by us.

—The appliance is still in the possession of the original purchaser.

All service work under this guarantee must be undertaken by a Zanussi Network Service Centre (or the Zanussi Authorised TV Service Dealer).

Any appliance or defective part replaced shall become our property.

Exclusions

This guarantee does not cover:

—Damage or calls resulting from transportation, improper use or neglect, the replacement of any light bulbs or removable parts of glass or plastic.

—Costs incurred for calls to put right machines improperly installed or calls to machines outside the UK and the Republic of Ireland.

—Appliances found to be in use within a commercial environment, plus those which are the subject of rental agreements.

—Television receivers - routine adjustment, or poor reception resulting from a source outside of the receiver.



ZANUSSI 5 YEAR COVER CONDITIONS

For a once-only payment you can extend your Standard Guarantee to 5 years. All the conditions and exclusions of the Standard Guarantee apply.

Notes

1. Products supplied as "seconds", refurbished, damaged or shop-soiled are not eligible for Zanussi 5 year cover.

2. The issue of a cover does NOT by virtue of our having done so, nullify the exclusions.

3. The Engineer will need to check the details of your Cover card and may make a charge for his services if it is not presented to him at the time of his call.

4. The date of purchase, or the date of initial payment (deposit) of the appliance will be deemed the date of commencement of cover.

5. Covers issued are not refundable or transferable.

ZANUSSI
The appliance of science